

D900.SHX Linear LED downlight Datasheet



Product codes

Unit:	Series:	Colour temp. (K):	Beam angle (°):	Colour:
D900.SHX	LN	3K 4K	10 40	B (Black) W (White)

Photometrics

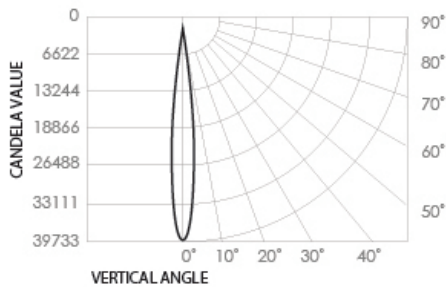

Source lumen output: 1255lm
 Delivered lumen output: 951lm
 Efficacy: 59lm/W
 Colour temp.: 3000K
 Beam angle: 10°

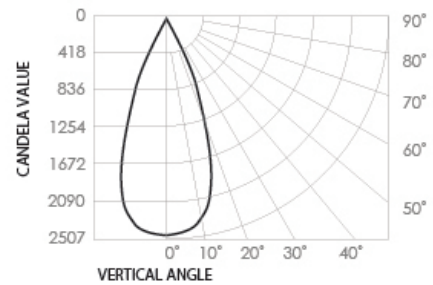

Source lumen output: 1255lm
 Delivered lumen output: 960lm
 Efficacy: 60lm/W
 Colour temp.: 3000K
 Beam angle: 40°

Dimensions (mm)

Front view

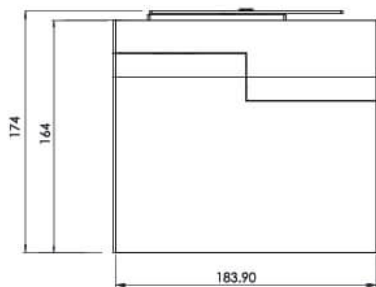

Side view



Electrical

Input voltage: 220-270V	Power usage: 16	Driver power factor: >0.9	IP rating: IP44	Surge protection: 3100V
Dimmable: Yes				

Operational

Operating temp.: -30 to 85°C	Average temp.: 60°C	Ambient temp.: -28 to 50°C	Lifetime: 50,000 hrs (@TA25)	Source Lumens: 1255lm or 1280lm
--	-------------------------------	--------------------------------------	--	---

Physical

Gimbal angle: 90°/360°	Warranty: 7 years
----------------------------------	-----------------------------

Compatibility

Recommended Dimmers:
"Compatible with leading home automation systems and dimmers.
Recommended Dimmers:
Universal, Trailing Edge, Leading Edge.

*For more details please refer to:
<https://brightgreen.com/digital-driver>
All systems are unique, please
call 1300 672 499 for advice on your installation."

Installation

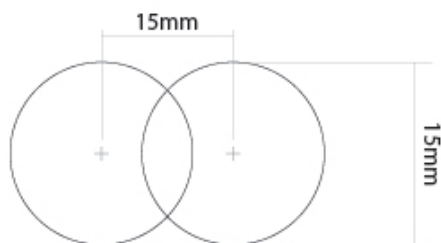

Step 1
Using a 25mm hole saw, cut two holes in the ceiling with the centre points 15mm apart at the desired location.

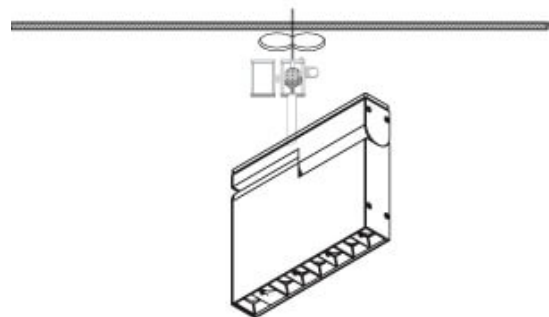

Step 2
Thread the power cable through the ceiling. Open the junction box and connect the power cable. Reattach the cover of the junction box and return it into the ceiling.

Installation

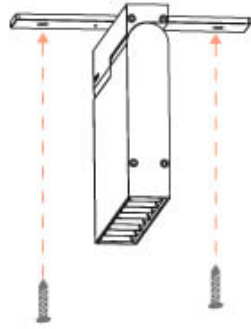

Step 3
Mount the unit to the ceiling using the 2 screws provided.

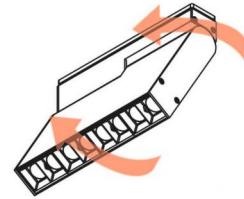

Step 4
Once the light is installed, orient the luminaire to focus the light as required.